

BEFORE YOU BEGIN:

PLEASE READ THROUGH THE INSTRUCTIONS AND INSPECT THE KIT BEFORE YOU GET STARTED.

Tools: You may need basic hobby tools such as a hobby knife, files, and sandpaper as well as glue to complete the assembly process.

Glue: We recommend using both superglue and PVA (white glue). Super glue is necessary for gluing any plastic, acrylic, or resin parts and sets very quickly. PVA gives you more working time if you need it for larger areas or for parts that need extra finesse to get lined up perfectly.

Cleaning Parts: The sprue points where parts were attached to the sheets can be sanded flush or carefully saved with a hobby knife. We do not recommend scaping as you would with plastic or resin models as it tends to make the MDF fray and get fuzzy. Part cleaning with a hobby knife is easiest if done before assembly, but can frequently be done after if you have files and sandpaper on hand. Where possible, we try to place sprue points in our designs to be in hidden places to avoid the need for cleaning on many parts.

Priming: We highly recommend priming with a FLAT enamel spray paint. Rustoleum and Krylon make these types of paint and are what we use in the studio.

Painting: Paint with your normal hobby and spray paints to finish your project.

Thank you so much for your purchase and please reach out if you have any questions or run into any issues.

Email us at: support@deathraydesigns.com
Chat us on Facebook: [FB.com/DeathRayDesigns](https://www.facebook.com/DeathRayDesigns)



1

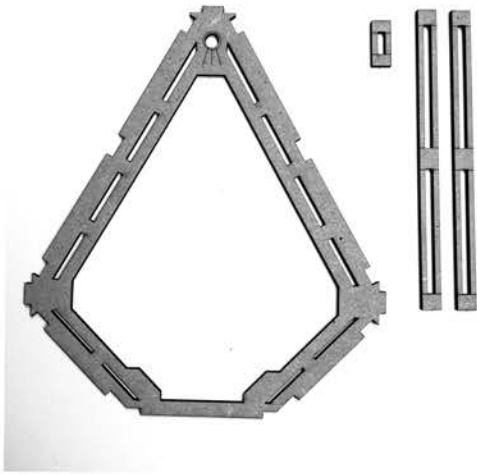

Gather these parts (x2)

2



Glue Strips on the upper edges as shown to make the Portal Core

3

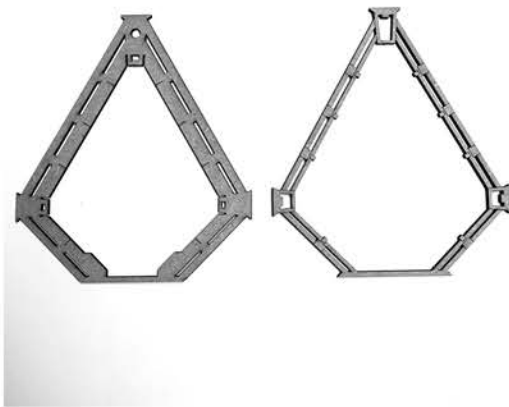

Gather these parts (x2)

4

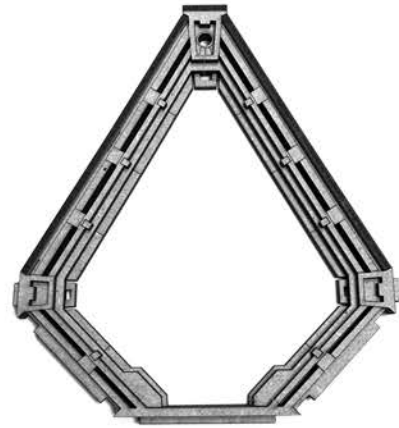

Glue the inner and outer detail plates onto the Portal Core as shown, all engraved details facing out.

5

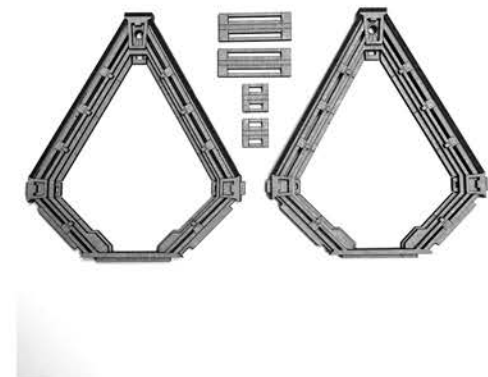

Once you do this process twice, take those constructs and gather the other parts shown

6



Glue the strips along the bottom of both constructs with the details facing out

7



There should be a gap at the top like this.
This is where the acrylic drop-in will go later

8

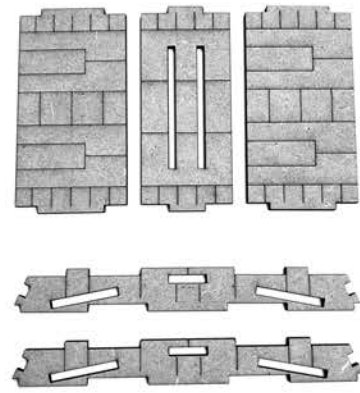

Gather these parts

9



Glue slats in one of the sides. Pay attention
to the orientation of the engraved details.

10



Glue the other side on

11

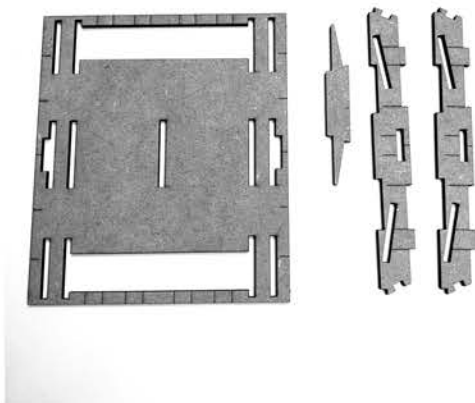

Gather these parts

12

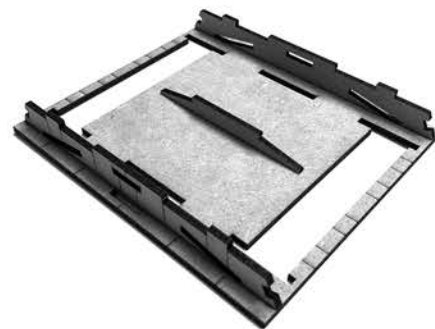

Glue the outermost wall panels into the base
as well as the central support

13

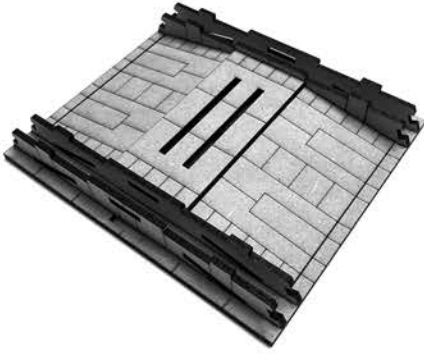

Glue the construct from step 10 on top of the previous step. You may have to apply pressure to get the central support to snap in.

14

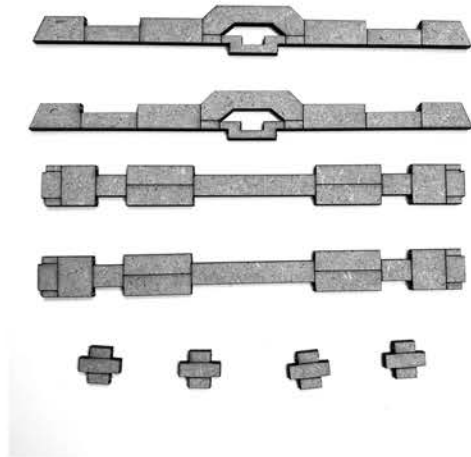

Gather these parts

15

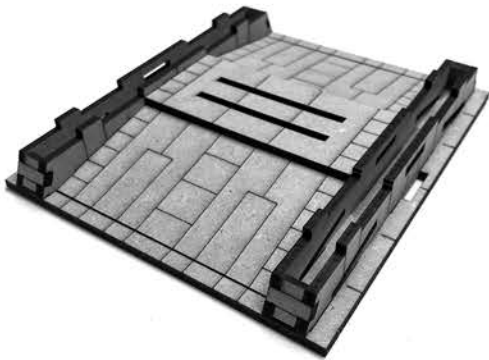

Glue the small crosses into the front of side walls

16

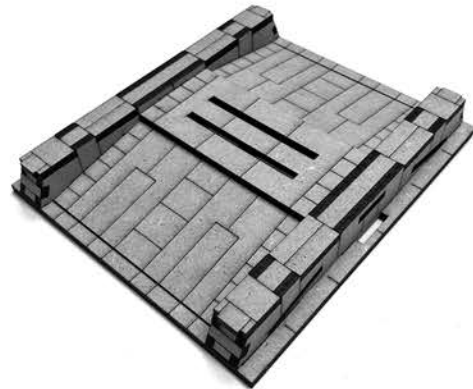

Glue the top slats on the side walls

17



Glue the detail panels onto the sides as shown

18



Glue the Portal from step 7 into the slots on the base